

Pump 1 (RED Receptacle)

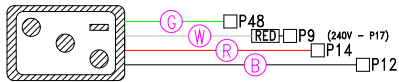

Pump 2 (PINK Receptacle)

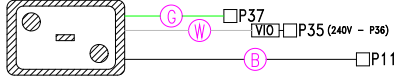

Air Blower (PURPLE Receptacle)

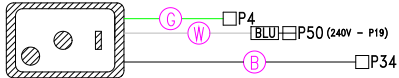

Ozone (YELLOW Receptacle)

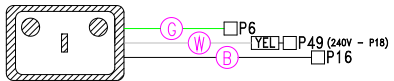

Fiber Optic (GREEN Receptacle)

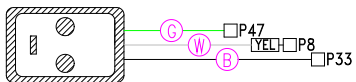

Light (WHITE 3-Pin Receptacle)

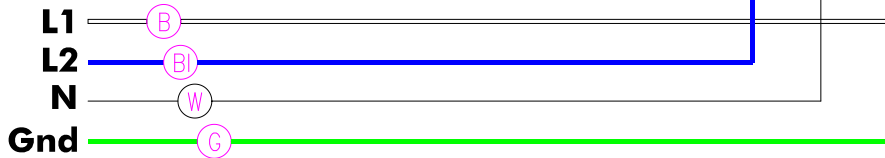
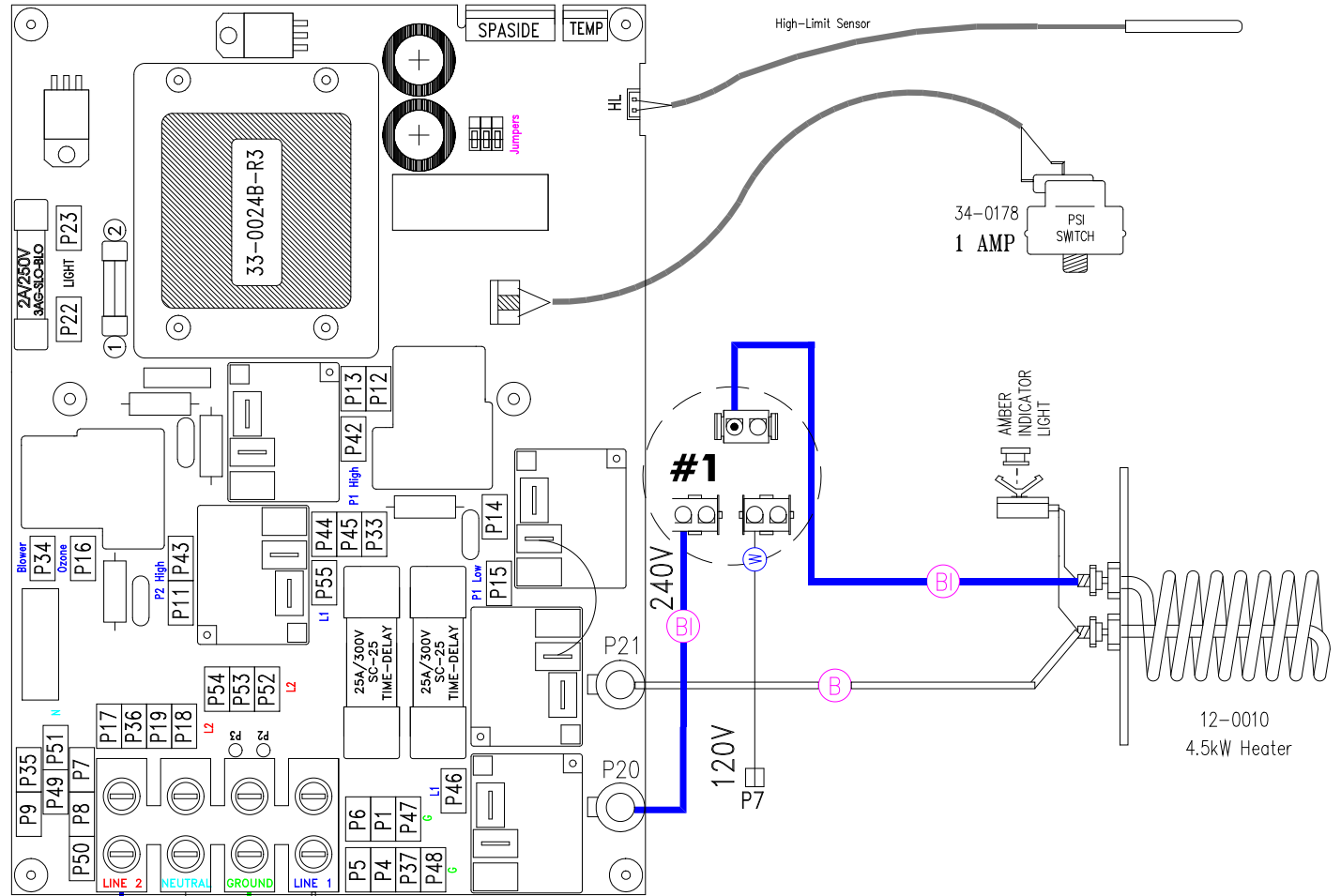
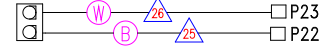

LEGEND	
	- 1/4" QUICK CONNECT
	- 1/4" QUICK CONNECT PIGGYBACK
	- FORK CONNECTOR
	- RING CONNECTOR
	- SOCKET CONNECTOR
	- PIN CONNECTOR

HYDRO-QUIP
CORONA, CA (909) 273-7575

Manufacture Notes: #1 For 240V operation of heater, plug must be installed into 240V receptacle

Dwg. No.
M556AH-DKQY-ZS

Drawn
BH

Rev
0

Wire Color Code

Approved By:

Date
04.26.05

B - Black	G - Green
Br - Brown	Bl - Blue
R - Red	V - Violet
O - Orange	W - White
Y - Yellow	Gr - Gray

Diagram No.
8014